

A PROJECT : _____
ITEM #: _____

QTY OF **FRAMES** REQ'D → W X H

MATERIAL : 304 L SS
 316 L SS

QTY OF **LOGS** REQ'D → W X H

MATERIAL : 304 L SS
 316 L SS
 ALUMINUM

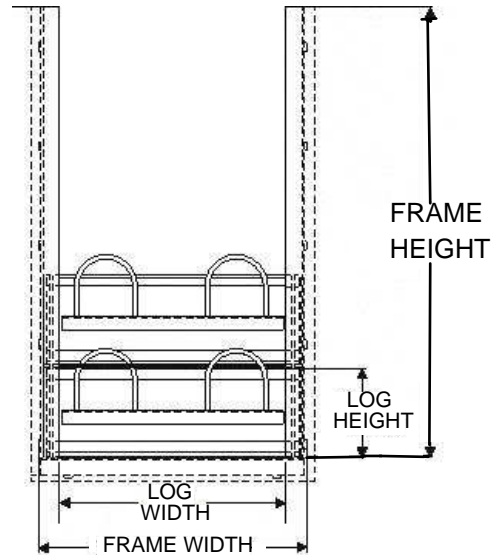

B MOUNTINGS

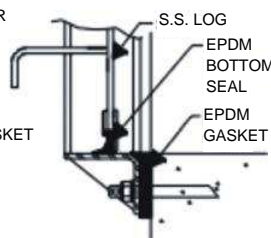
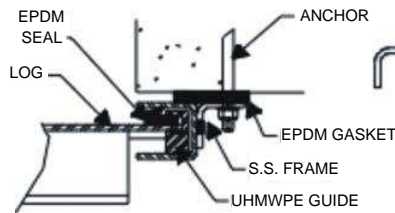

CW

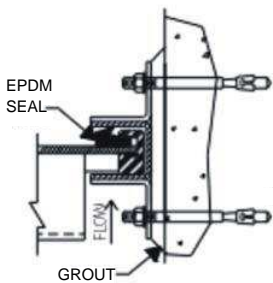

EC

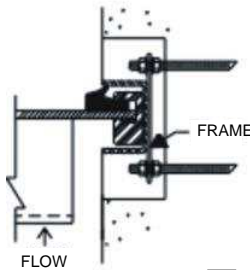
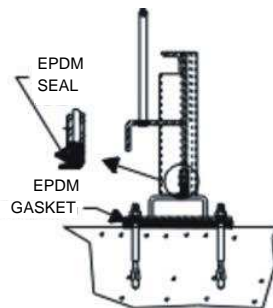

FE

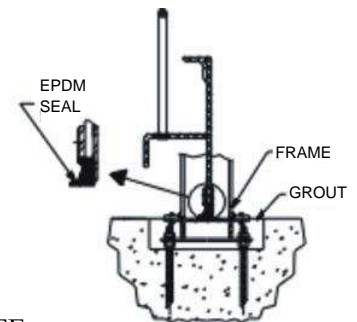

C HOIST REQUIREMENTS

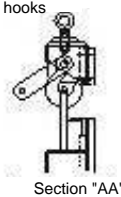
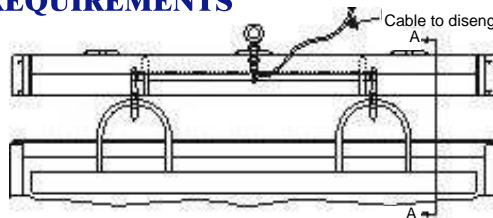

LIFTING DEVICE
REQUIRED

D REMARKS