

# TLS™ TUNABLE LASER SOURCE



The TLS combines NKTP's supercontinuum lasers and Photon etc's LLTF. This continuously tunable laser source has both a high spectral power density and spectral resolution over a wide range of wavelengths (400 to 2500 nm). Thanks to NKTP's wide selection of SuperK lasers and Photon etc.'s customizable LLTFs, many TLS configurations are possible.

## TLS APPLICATION OVERVIEW

- » Spectroscopy: pump-probe, PL, PLE, LBIC, etc.
- » Hyperspectral darkfield and luminescence imaging
- » Photodetector calibration
- » Reflectance measurements of tissue for cancer research

### LLTF TECHNICAL SPECIFICATIONS

(extended and reduced spectral ranges also available**)	CONTRAST VIS	CONTRAST SWIR	CONTRAST EXT-IV		CONTRAST X
Spectral range	400-1000 nm	1000-2300 nm (2500 nm optional)	400-2300 nm (2500 nm optional)		X represents a custom spectral range
Bandwidth (FWHM)***	< 2.5 nm	< 5.0 nm	400-1000 nm < 2.5 nm	1000-2300 nm < 5.0 nm	0.15 - 0.9 nm
Out of band rejection	<-60dB@±40nm <-30dB@±10nm	<-60dB@±80nm <-30dB@±20nm	<-60dB@±40nm <-30dB@±10nm	<-60dB@±80nm <-30dB@±20nm	Depends on the bandwidth
Maximum input average power	HP8 (up to 8W)	HP8 (up to 8W)	HP8 (up to 8W)		HP4 (up to 4W)
Peak efficiency	Typically 65%				
Optical density (OD)	> OD6 (measured at 1064 nm)				Depends on spectral range
Damage threshold	< 5 GW/cm <sup>2</sup> peak power @ 1064 nm, 8 ns				
Input beam diameter	< 5 mm				
Input beam divergence requirement (full angle)	< 1.5 mrad				
Wavelength resolution (relative)	FWHM / 8				
Pointing stability	< 1 mm total lateral displacement @ 1 m from filter				
Scanning speed (multiple step)	20 ms stabilization time for 0.01 nm step 20 ms stabilization time for 0.1 nm step 20 ms stabilization time for 0.2 nm step 25 ms stabilization time for 1 nm step 28 ms stabilization time for 2 nm step 35 ms stabilization time for 5 nm step 50 ms stabilization time for 10 nm step				
Software	PC (Windows10 - 64-bits) with PHYSpec™ control and analysis software (computer not included), connection via USB 2.0 (1.1 compatible)				
Dimensions ( L x W x H )	9 x 6.3 x 6.7 (inches) 23 x 16 x 17 (cm)		11.8 x 9.1 x 6.7 (inches) 30 x 23 x 17.4 (cm)		9 x 6.3 x 6.7 (inches) 23 x 16 x 17 (cm)
Operating temperature	10 to 40 °C				
Storage temperature	0 to 50 °C				
Power requirement	120 VAC / 60 Hz 230 VAC / 50 Hz				
**Eg: 500-2000 nm, 400-1700 nm, 500-900 nm, 400-650 nm, 650-1000 nm, 1000-1700 nm, 1700-2300 nm, etc.					
***Valid if the divergence of the input beam does not exceed 1 mrad					
The above specifications describe the LLTF and are independent of the laser. Please contact sales@photonetc.com to obtain specifications for the supercontinuum or other tunable laser sources.					

### LLTF VIS AND SWIR OUTPUT POWER

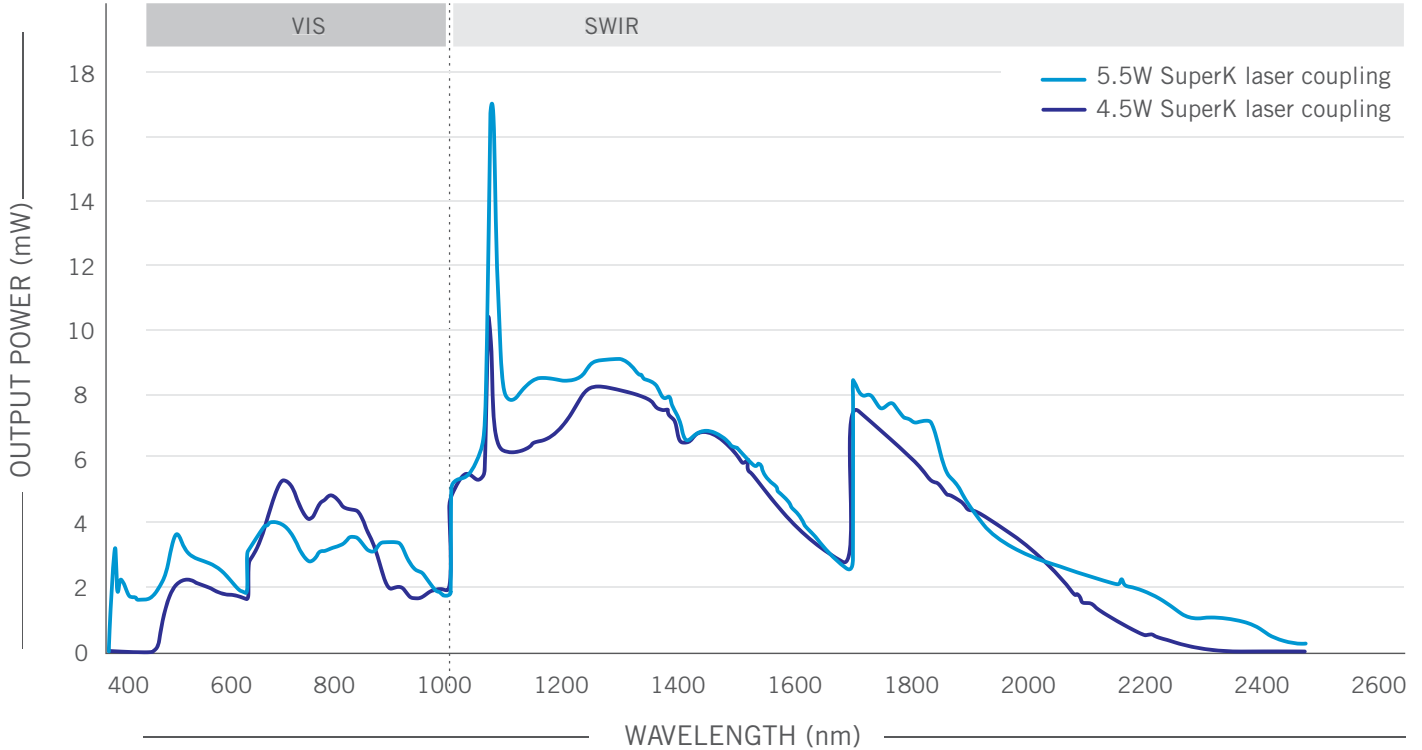

### LLTF EXTENDED (500-2000 nm) OUTPUT POWER

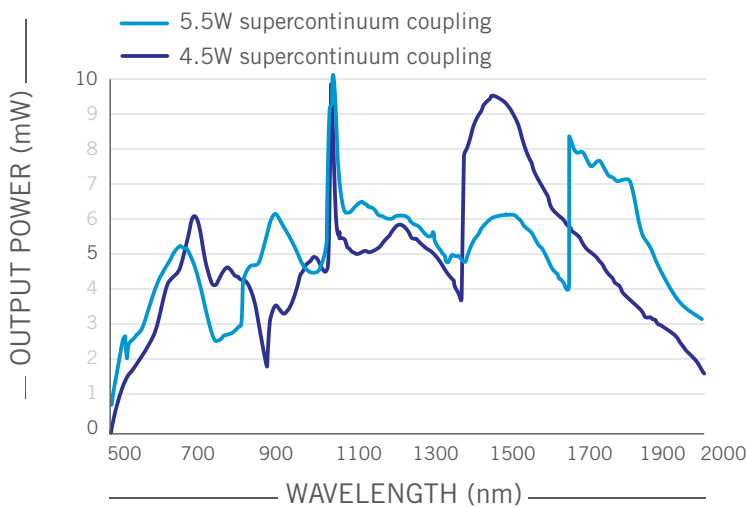
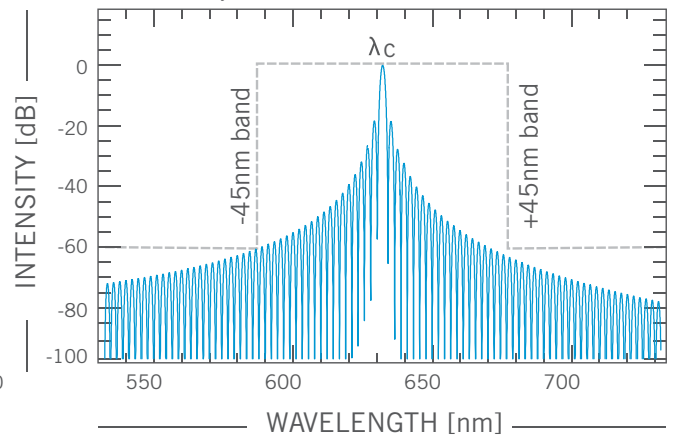
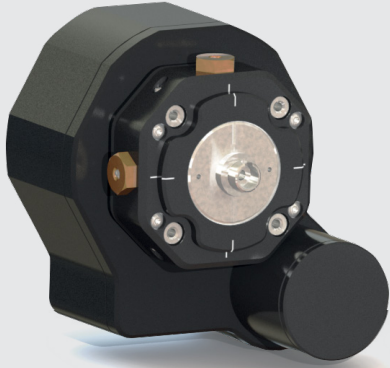

Illustration of the out-of-band rejection of a volume holographic grating at  $\lambda_c = 632$  nm. Bands of  $\pm 45$  nm are presented and an out-of-band rejection of -60 dB is obtained.



OPTIONS AND ACCESSORIES				
(extended and reduced spectral ranges also available**)	<b>CONTRAST VIS</b>	<b>CONTRAST SWIR</b>	<b>CONTRAST EXT-IV</b>	<b>CONTRAST X</b>
Enhance SWIR	N/A		Up to 2500 nm	
Fibered output	An X-Y-Z translation adjustment allows coupling optimization			
Harmonic filter	Blocks the harmonics coming from the region 400-500 nm	Blocks the harmonics coming from the regions 500-850 nm and/or 850-1150 nm	Blocks the harmonics coming from the regions 400-500 nm and/or 500-850 nm and/or 850-1150 nm	The filter is chosen according to the spectral range
Alignment kit (for free space)	In free space configuration (input/output), the alignment kit allows the user to rapidly find the correct alignment			
	**Eg: 500-2000 nm, 400-1700 nm, 500-900 nm, 400-650 nm, 650-1000 nm, 1000-1700 nm, 1700-2300 nm, etc.			

## ACCESSORIES



### FIBEROPTIC INPUT/OUTPUT

The LLTF Contrast, in its basic configuration, delivers a collimated free-space output beam. The fibered output option takes this beam and couples it into a fiber to fit the needs of various applications. An X-Y-Z translation adjustment allows coupling optimization. Compatible with most standard fiber connectors (ex. FC/PC, FC/APC, etc.)

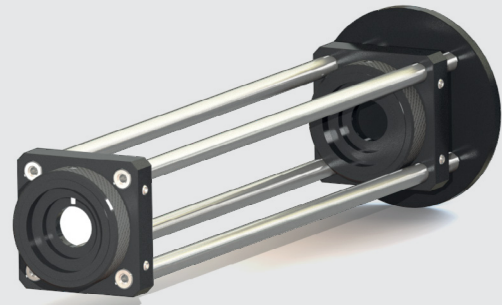

### ALIGNMENT KIT (FOR FREE-SPACE)

In free-space configuration, the alignment of the input laser into the LLTF is a challenging task without the proper tools. The alignment kit allows the user to rapidly find the correct alignment. Two irises, mounted on removable posts, are easily placed at the entrance of the filter. The laser beam then simply needs to follow the path created by the irises.

## OPTIONS

### HARMONIC FILTER

Like in every diffraction grating, the 2<sup>nd</sup> harmonic of a given wavelength is present in the output light of the LLTF Contrast™. Fortunately, we have a set of harmonic longpass filters that blocks this 2<sup>nd</sup> harmonic to bring it down to OD6. We generally recommend using these filters in order to get the full advantage of the LLTF optical purity. The harmonic filter performances we offer for the Contrast VIS and SWIR are described with the following graphics.

HARMONIC FILTER - VIS-HF2

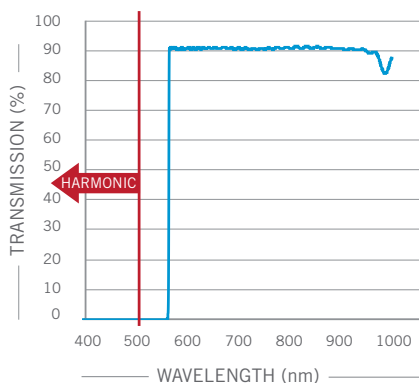

HARMONIC FILTER - SWIR-HF2

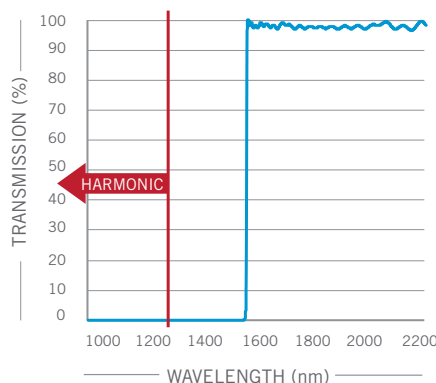

HARMONIC FILTER - SWIR-HF12

